

ELECTRIC STORAGE WATER HEATER

Operation Manual

QHFJI - M6

Read this manual carefully before installation and use

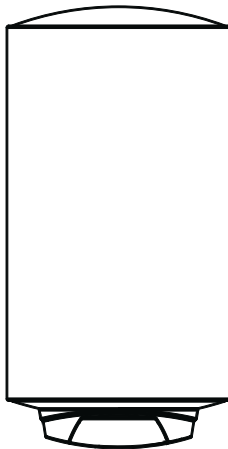

CONTENTS

Special Reminders	03
Features	06
Product Specification	06
Dimension Specification	07
Installation Method	08
Method of Application	13
Detailed Description of Functions	16
Cleaning And Maintenance	18
Electrical Schematic Diagram	18
Faults and Troubleshooting	19
App connection instructions	20
Packing List	22
Recycling and Reuse	23

Special Reminders

The following safety guidelines are intended to prevent unforeseen risks or damage from unsafe or incorrect operation of the appliance. Please check the packaging and appliance on arrival to make sure everything is intact to ensure safe operation. If you find any damage, please contact the retailer or dealer. Please note modifications or alterations to the appliance are not allowed for your safety concern. Unintended use may cause hazards and loss of warranty claims.

Read these operating instructions carefully and attentively before using / commissioning the unit and keep them in the immediate vicinity of the installation site or unit for later use!

Caution Risk Of Injury !

Before installing this water heater, check and confirm that the earthing on the supply socket is reliably grounded. Otherwise, the electrical water heater can not be installed and used. Do not use extension boards. Incorrect installation and use of this electrical water heater may result in serious injuries and loss of property.

Special Cautions

Warning

Non-professionals are not allowed to disassemble the thermal switch to reset. Please contact professionals to maintain. Otherwise our company will not take responsibility if any quality accident happens because of this.

- (1) The supply socket must be earthed reliably, The rated current of the socket shall not be lower than 16A. The socket and plug shall be kept dry to prevent electrical leakage.
- (2) The wall in which the electrical water heater is installed shall be able to bear the load more than two times of the heater filled fully with water without distortion and cracks. Otherwise, other strengthening measures shall be adopted.

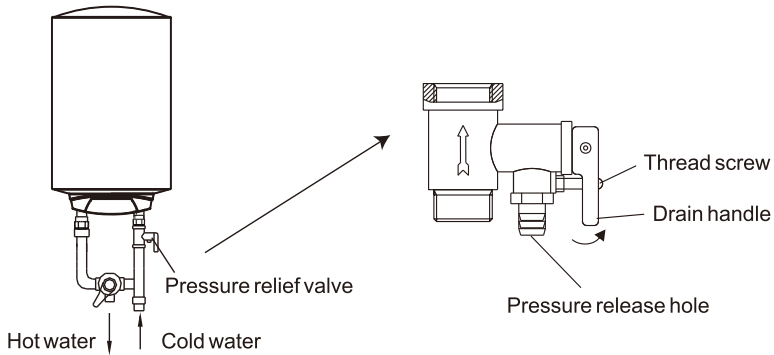

(Fig.1)

- (3) If there is no power for an extended period or if it is not used, the water inside must be completely drained.
- (4) The safety valve should be placed on the inlet (see Fig. 1), and care should be taken to ensure it is not exposed to moisture. Water may come out of the pressure relief valve. The pressure relief valve should be checked and cleaned regularly to ensure it does not become blocked.
- (5) When using the heater for the first time (or the first time after maintenance), it should not be turned on until it is completely filled with water. When filling it with water, the hot water faucet should be opened to expel the air. This faucet should be closed once the heater is completely filled.
- (6) The water heater is not intended for use by persons (including children) with reduced physical, sensory or mental capabilities, or lack of experience and knowledge, unless they have been given supervision or instructions concerning use of the appliance by a person responsible for their safety. The use of the appliance by children and vulnerable people must be done under supervision.

- (7) During heating, there may be drops of water dripping from the pressure release hole of the pressure relief valve. This is a normal phenomenon. If there is a large amount of water leak, please contact customer care center for repair. This pressure release hole shall, under no circumstances, be blocked; otherwise, the heater may be damaged, even resulting in accidents.
- (8) Since the water temperature inside the heater can reach up to 75°C, the hot water must not be exposed to human bodies when it is initially used. Adjust the water temperature to a suitable temperature to avoid scalding.
- (9) If the flexible power supply cord is damaged, the special supply cord provided by the manufacturer must be selected, and replaced by the professional maintenance personnel.
- (10) If any parts and components of this electrical water heater are damaged please contact customer care center for repair.
- (11) Children should be supervised to ensure that they do not play with the appliance.
- (12) The drain pipe should be in a frost protected area. Users must protect inlet and outlet drain lines from freezing.
- (13) The electric water heater meets the requirements of EN-60335-1, EN-60335-2-21.
- (14) Do not cut off power supply before maintenance, to avoid danger like electric shock.
- (15) During normal operation, the inlet valve shall be always kept open.
- (16) In order to drain away the water inside the inner container, it can be drained away from the pressure release valve. Twist the thread screw of the pressure release valve off, and lift the drain handle upwards.

Features

- Purpose:
The electric water heater is suitable for hot water shower and washing in families, enterprises and institutions, service industries and other places .
- Characteristic:
 - 1.With temperature regulation function, the temperature can be adjusted flexibly in the range of 30°C~ 75°C.
 - 2.The heating indicator light indicates the current working state.
 - 3.Automatic control of heating and insulation ensure hot water supply at any time.
 - 4.It has multiple protections such as overtemperature protection, water overpressure protection (automatic pressure relief when the inner tank pressure is too high), anti hot water backflow and so on.
 - 5.The product features an enamel-coated heating element and an enamel-coated inner tank, which are resistant to corrosion and scaling. Additionally, it is equipped with a magnesium anode rod protection device for the inner tank, ensuring an extended service life.
 - 6.The insulation layer adopts thickened polyurethane overall foaming, which has good insulation effect, energy saving and power saving.
 - 7.The water mixing valve is used to regulate the water outlet, which is simple and flexible.
 - 8.Multi purpose: it can supply water for multiple water points at the same time.

Product Specification

Rated Capacity (L)	30	50	80	100	120	150
Rated Power	1500W			2000W		
Rated Voltage	220~240VAC/50-60Hz					
Rated Pressure	0,8MPa					
Maximum Set Temperature	80°C					

Dimension Specification

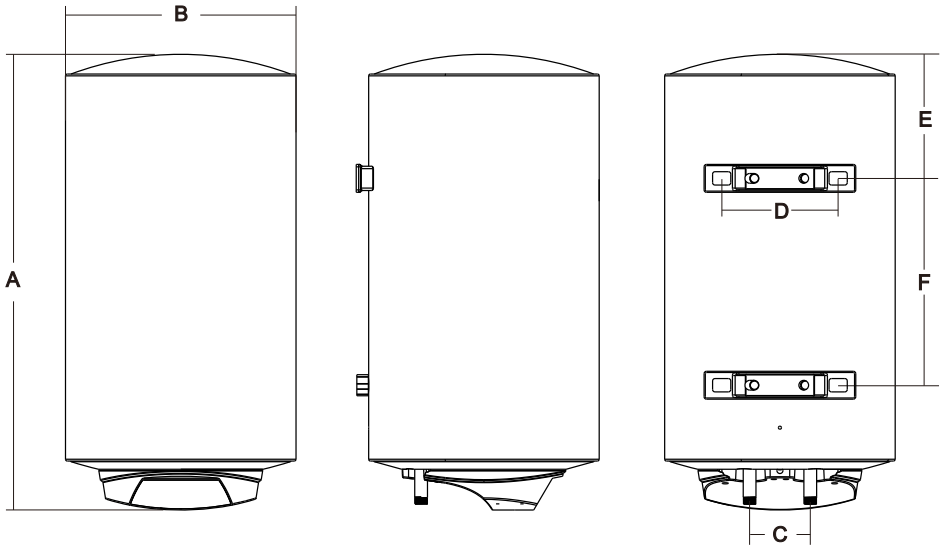

Capacity	30L	50L	80L	100L	120L	150L
Dimension(mm)						
A	635	760	840	1000	1150	1380
B	340	380	450	450	450	450
C	100	100	100	100	100	100
D	200	200	200	200	200	200
E	185	205	205	230	210	210
F	240	341	331	447	640	865

Installation Method

The electric water heater shall be installed by professional installation personnel in accordance with the requirements of the national standard of code for installation of electric water heater.

1. Installation Preparation

- (1) Professional installation personnel shall prepare installation tools and necessary measuring qualified inspection instruments.
- (2) Check whether the electric water heater is in good condition and whether the attached documents and accessories are complete.
- (3) Carefully read the operation manual to understand the function, operation method, installation requirements and installation method of the electric water heater to be installed.
- (4) To check the power supply of users, 220~240VAC/50~60Hz power supply must be used. The electrical connection of electric water heater shall generally adopt special branch circuit, and its capacity shall be greater than 1.5 times of the maximum current value of electric water heater. The position of the separate fixed socket shall be placed in a safe position where there is no danger of electric shock and its water cannot be splashed. The separate fixed socket used by the electric water heater shall be inspected by visual inspection and special measuring devices (phase meter, test pen, grounding resistance meter, etc.) to ensure that the live wire and zero wire are installed correctly and grounded reliably. Carefully check whether the capacity of electric energy meter, wire and separate fixed socket meet the requirements of electric water heater. Check the water pressure of tap water with a pressure gauge. A safety valve should be installed before the water inlet pipe. The rated pressure of the water heater is 0,8MPa. If the inlet water pressure is over 0,8MPa, the safety valve would discharge the pressure the pressure by leaking, which is the protection to the water heater.
- (5) Assist users in selecting the installation position of electric water heater: avoid the place where flammable gas leaks or the environment with strong corrosive gas. Avoid places where strong electric and magnetic fields act directly. Avoid direct sunlight, rain and wind. Try to avoid places prone to vibration. Try to shorten the length between the electric water heater and the water point to reduce the heat loss of the pipeline. There must be a floor drain

with sufficient drainage capacity near the lower part of the installation to avoid failure of drainage. In order to facilitate future repair, maintenance and relocation, a certain space must be reserved for the installation position of the electric water heater. The bearing capacity of the mounting surface shall not be less than 4 times of the total mass of the electric water heater filled with water, otherwise the user needs to install a support bracket under the electric water heater to ensure safety.

Notes:

- ① Before proceeding with the hydraulic connection, it is essential to clean the supply pipes to prevent introducing metallic or foreign particles into the water heater.
- ② Install the water heater according to the diagrams in Figures 1 and 2. The water heater must be installed with the safety group, which includes a non-return valve. (Provided with the water heater.)
- ③ Do not install any hydraulic accessories between the safety group and the cold water pipe (such as a stop valve, non-return valve, etc.).
- ④ Disposing of a household appliance separately means avoiding possible negative consequences for the environment and health that could result from improper disposal, and allows for the treatment and recycling of the materials it is made of, achieving significant energy and resource savings. For more information, contact your local authority or the store where you purchased the product.
- ⑤ During the heating period, the water expands, causing a drip (approximately 3% of its capacity per heating cycle). Do not worry, this is a normal phenomenon. To drain the water heater, you need to operate the safety group lever as shown in Figure 3. It is advisable to periodically operate this lever to prevent it from becoming stuck and to check its proper functioning.
- ⑥ When the pressure of the supply network exceeds 0,5MPa, it is mandatory to install a Pressure Reducer at the household inlet, set to 0,3MPa or 0,4MPa.
- ⑦ If plastic pipes are used for the installation, it is necessary to consider the pressure and temperature conditions to which they will be subjected. The water pipes connected to the electric water heater must be pressure-resistant to 0,8MPa and heat-resistant above 100°C, with sealing tape wrapped at the joints to ensure leak-proof sealing.

2. Installation Operation

- (1) The attached accessories shall be used for the installation of electric water heater, and professional installation personnel shall not replace, omit or reform at will.
- (2) During installation, attention shall be paid not to damage the safety guarantee structure of the building.
- (3) The pipes and fittings used for water heater installation must comply with the national standard and also follow the directions indicated by the manufacture in this manual. No one-way valve or shut-off valve should be installed between the water heater and the safety valve to avoid interfering with their normal operation. If an extra one way vavle is added between the inlet pipe of the product and safety valve which is connected to the city pipe, an expansion tank qualified according to the standard after the one way valve is required in order to avoid over pressure and damage to the tank.
- (4) Determine the installation position of the electric water heater. Avoid the reinforcement and embedded pipeline in the wall. Use an impact drill to create two holes in the solid wall with a medium diameter of $\phi 13$ mm and a depth of 65mm (for 30-120L) or $\phi 16$ mm and a depth of $\phi 90$ mm (for 150L). The two holes shall be on the same horizontal line, and the hole spacing is shown in the table above. More than 500mm space shall be reserved on the right side of the electric water heater for maintenance.

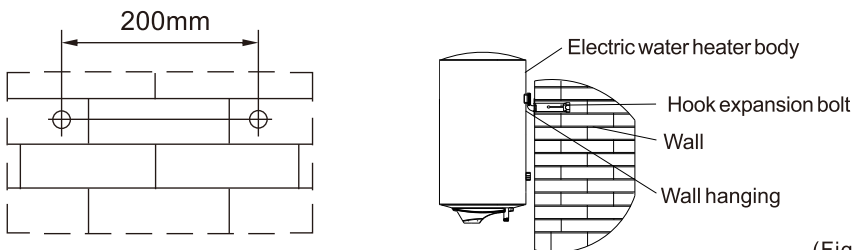

(Fig.2)

Note: floor mounted installation is not allowed.

- (5) Insert the hook expansion bolt into the hole, tighten it and make the hook upward.
- (6) Lift the electric water heater, align the two square holes of the two wall hangers with the hooks of the two hook expansion bolts, and check whether the hook expansion bolts are loose to ensure that the electric water heater is firmly installed.
- (7) Connect the safety valve, drainage hose, water mixing valve, tap water inlet pipe and shower with the electric water heater (install a sealing ring at the joint).

Notes:

- ① The safety valve (factory original identification 0,8MPa) in the accessories shall be installed on the water inlet joint, and the thread sealing PTFE tape shall be wound to ensure sealing. The arrow direction shall be consistent with the water inlet flow direction of the electric water heater (as shown in Fig 3). The net sealing gasket shall be installed at the cold water inlet of the safety valve. It shall be installed in a frost free environment. The safety valve can prevent the tank pressure from exceeding the rated pressure by 0,1MPa. If the pressure in the tank is too high, the safety valve will automatically open and drain water from its pressure relief port to release the pressure.
- ② The dimension of each pipe part is G1/2", Connection of pressure relief valve with the heater on the inlet of the water heater. In order to avoid

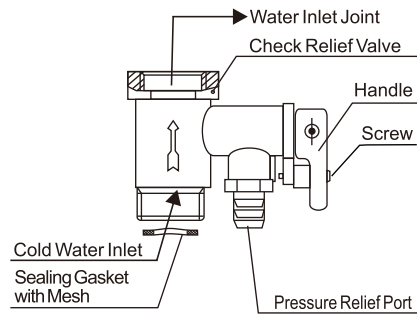

(Fig.3)

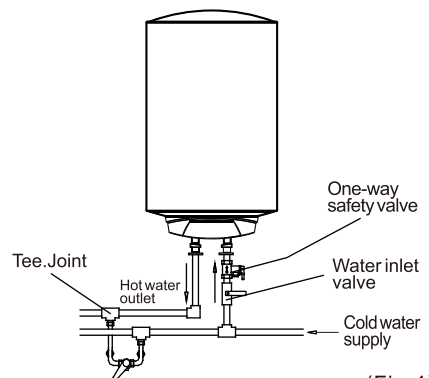

(Fig.4)

leakage when connected to the pipelines, the rubber seal gaskets provided with the heater must be placed at the end of the threads.

- ③The water pipe connected to the electric water heater must be able to withstand pressure of 0,8MPa and temperature of more than 100°C, and the joint shall be wrapped with sealing tape to ensure sealing.
- ④Where water is used, it shall be able to drain smoothly.
- ⑤Under normal use, the handle of the safety valve (Fig.3) should be opened regularly to remove calcium carbonate deposition. The method is: pull the discharge handle upward to the horizontal position (if the handle is equipped with screws, remove the screws with a screwdriver before doing this action), and confirm whether the safety valve is blocked (whether there is water discharge). If it is blocked, please contact the maintenance department.
- (8)If users want multi-channel water supply, they can connect the water pipe according to the method shown in Fig 4.
- (9)After confirming that the rated values of electricity meters, wires, switches, sockets and fuses in the power supply system meet the power consumption requirements of this product, connect a separate power socket at an appropriate position to supply power to the electric water heater. The installation height of power socket from the ground shall not be less than 1,8m.

Notes:

- ①Do not put the socket in a place where water is easy to get into.
- ②The socket must have a reliable grounding wire.
- ③The socket should be kept dry to prevent leakage. Electrical installation must be carried out by professionals.

3. Inspection and Commissioning

- (1)The pipeline connection and direction shall be reasonable, and there shall be no water leakage at each connection.
- (2)The electrical configuration shall be safe and correct, the electric water heater shall be reliably grounded, and the power plug and socket shall cooperate closely.
- (3)The mechanical connection shall be firm and reliable.
- (4)Check the possible leakage parts of the shell with a test pen or multimeter to ensure that the electric water heater is safe and normal.
- (5)The electric water heater shall operate according to the use method in this manual, and all performance indexes shall be consistent with this manual.

Method of Application

- When using the water heater for the first time or after draining the tank and then using it again, the tank of the water heater must be filled with water first. The method is: open the water inlet valve, pull up the handle of the water mixing valve and turn it clockwise to the high-temperature area, that is, start injecting water into the inner tank. When the hot water outlet comes out, it indicates that it is filled with water, then turn the handle of the water mixing valve counterclockwise to the low-temperature area and push it to the closed position (as shown in Fig 5).

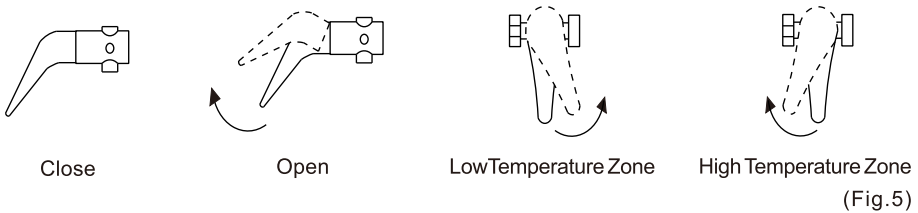

- Plug the power cord into the electrical outlet to power on the electric water heater, and at this moment, the heater's display screen lights up. If the power cord is damaged, it must be replaced by the manufacturer or its maintenance department or similar professionals in order to avoid danger.
- Instructions for the Leakage Protection Plug (as shown in Fig 6)

3.1 The leakage protection plug cannot be used as a switch for the product. During daily use, please conduct regular tests on the leakage protection plug using the following method:

- Testing the reliability of a leakage protection plug: Press the test button. At this point, the indicator light on the plug should go out and the reset button will pop up. Then, press the reset button again, and if the indicator light turns on, it proves that the leakage protection plug is functioning properly. Otherwise, please stop using the electric

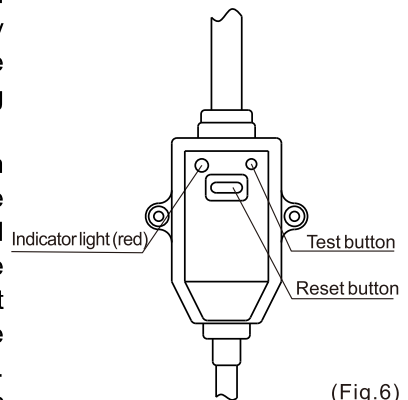

(Fig.6)

water heater immediately and contact the after-sales department for assistance. Users should regularly inspect for electrical leakage (once a month) and follow the aforementioned steps to do so.

- 3.3 When using the product, if you need to temporarily disconnect the power supply, please press the test button on the leakage protection plug to cut off the power. If you directly turn off the power at the socket, the leakage protection plug will not provide protection.

4. Description of Operation

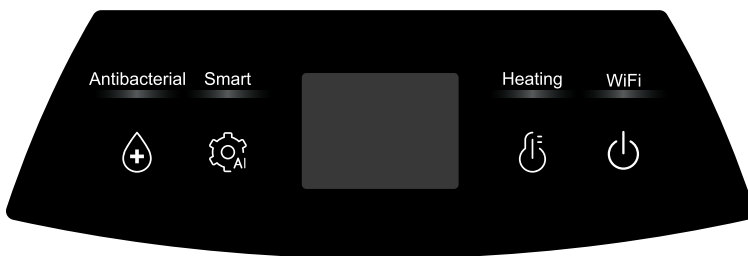

Schematic Diagram Of Operation Panel

Operation method

1. " ⏻ " Button:

Connect the power supply, and the display screen (including indicator lights) will fully light up for 2 seconds, entering standby mode or the state before the last power outage. Standby mode: The display screen shows the actual temperature; Press this button once to turn on the device and enter working mode, alternately displaying the actual temperature for 10 seconds and the set temperature for 3 seconds.

Long press the " ⏻ " key for 3 seconds to enter the APP distribution network. The buzzer beeps once, and wait for about 2 seconds before the WiFi indicator light flashes. At this time, you can follow the APP prompt to perform distribution network. After successful distribution network, the WiFi indicator light stays on.

When the network connection is not successful for more than 3 minutes, the WiFi indicator light will turn off. At this time, you can press and hold the " ⏻ " key for 3 seconds to restart the network connection.

2. " " Adjustment Button:

When the device is powered on, press the "  " key to enter the temperature setting mode. The set temperature parameter will flash on the display. Each subsequent press of this key will increase the set temperature by 1°C from the previously set value, cycling within the range of 30°C to 75°C. Continuously pressing the key will make the temperature flash and cycle sequentially through 30-31-32-33...75-30°C.

Holding down the key will change the parameter at a rate of 5 increments per second. If no changes are made to the temperature setting parameter within 5 seconds, the system will automatically confirm the current setting and enter the corresponding operating state, with the temperature parameter display ceasing to flash.

3. " " Smart Mode Button:

When the device is powered on, press and hold the "  " Smart Mode button for 3 seconds to enter Smart Mode. In Smart Mode, the system analyzes, processes, and memorizes the user's water usage habits from the previous week (if Smart Mode has been enabled for less than one week, it will first spend a full week learning and memorizing usage patterns. During this period, the Smart Mode indicator light will glow orange, and it will turn blue once the learning process is complete.). Subsequently, the water heater will initiate heating 1 hour in advance of the memorized water usage times.

During non-water-using periods, the water heater will also heat up at appropriate times to maintain a supply of warm water for use.

Note: If the water heater experiences a power outage or exits Smart Mode, all previously memorized data will be cleared.

To exit Smart Mode: Press and hold the "  " button for 3 seconds. The "Smart Mode" indicator light will turn off.

4. " " High-Temperature Bacteriostatic Button:

In the power on state, Press and hold the "  " key for 3 seconds this button to turn on or off the high-temperature antibacterial mode. When turned on, the antibacterial indicator light is on, and the set temperature is displayed as 80°C. After the system is heated to 80°C, it enters the insulation state. When the water temperature drops by 5°C, it is reheated to 80°C. At this point, start timing for 30 minutes before exiting the high-temperature antibacterial mode and entering the previous working mode.

Detailed Description of Functions

1. Heating function:

When turned on, the water heater directly heats up. When the water heater reaches the set temperature, it stops heating and enters the insulation state. If the water temperature drops below the set temperature by 8 degrees, then reheat and repeat the cycle. The "Heating" indicator light is on when in the heating state.

2. Thermal insulation function:

When entering the insulation state, the "Heating" indicator light goes out.

3. Automatic sleep function:

- 3.1 In the powered-on standby state, the brightness of the display screen dims (to half brightness).
- 3.2 In the powered-on state, if there is no key operation for 3 consecutive minutes (excluding during heating and anti-freezing modes), the device enters the screen saver state. In this state, the brightness of the display screen dims, and only the actual temperature is displayed, while the indicator light corresponding to the current operating mode remains illuminated.
- 3.3 The screen saver mode will not be activated during heating or anti-freezing states.
- 3.4 Pressing any key in the screen saver state will wake up the display (it will automatically wake up if entering anti-freezing mode), and the display will return to the content shown before entering the screen saver mode. Key operations can then be performed. Pressing the " ⏻ " key in the standby state will directly power on the device.

4. Memory function:

It has memory function (memory on/off state, set temperature, etc.), and can automatically return to the working state before power failure when powered on again after power failure.

5. Memory clearing function:

Press and hold both the " ⏻ " and " ⏏ " keys simultaneously for 3 seconds. The display screen will fully illuminate, and the device will reset to factory settings, accompanied by a "beep" sound from the buzzer. After 2 seconds, it will enter standby mode (in standby mode, upon power-on, the set temperature will be "75°C" under instant heating mode).

6. Anti freezing protection function:

When the system detects that the water temperature in the inner tank is $\leq 6^{\circ}\text{C}$ while the device is in the powered-on standby state, it will automatically initiate heating. Heating will cease when the inner tank temperature reaches $\geq 10^{\circ}\text{C}$. (During heating, neither the display screen nor the indicator lights will show any indication, adopting a concealed heating method.)

7. Beep function:

The sound is emitted by a buzzer, and it is required to sound clearly. When a fault occurs, it should sound 10 times, and each effective button operation should sound 1 time.

8. Safety self check function:

Whether in power on or standby mode, the machine performs real-time and comprehensive safety self checks (dry burning, sensor, overheating fault detection).

9. Alarm function and fault self check:

When dry burning, sensor 1/2, and overtemperature faults occur, the display screen flashes E2, E3/E5, E4 respectively, and other digital tubes and indicator lights do not display. At this time, all relays are disconnected and all keys are invalid; The system will return to standby mode only after the fault is resolved and powered on again.

Cleaning And Maintenance

Warning

Do cut off power supply before maintenance, to avoid danger like electric shock.

1. Check the power plug and outlet as often as possible. Secure electrical contact and also proper grounding must be provided. The plug and outlet must not heat excessively.
2. If the heater is not used for a long time, especially in regions with low air temperature (below 0°C), it is necessary to drain water from the heater to prevent damage of the water heater, due to water freezing in the internal tank. (Refer Cautions in this manual for the method to drain away the water from the inner container).
3. To ensure long reliable water heater operation, it is recommended to regularly clean the internal tank and remove deposits on the electric heating element of the water heater. Tank cleaning frequency depends on hardness of water located in this territory. Cleaning must be performed by special maintenance services. You can ask the seller for address of the nearest service center.

Electrical Schematic Diagram

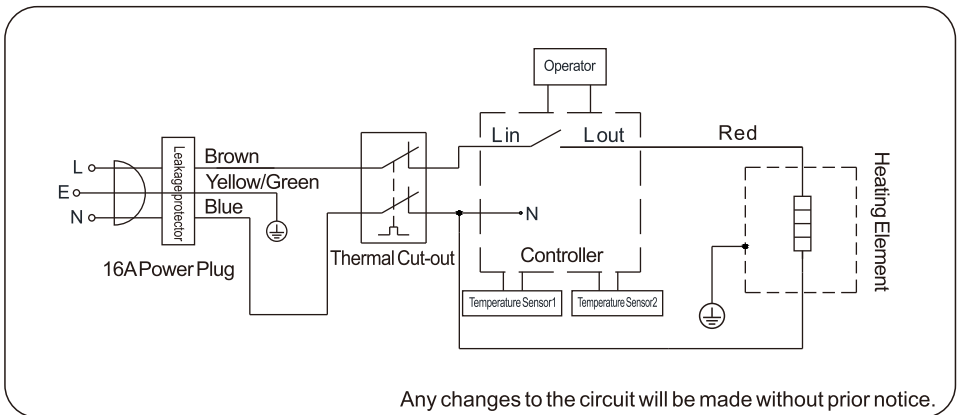

Faults and Troubleshooting

Faults	Analysis of Causes	Troubleshooting
No water from hot water outlet	The water supply system is cut off or the water pressure is too low	Check the water supply system
	The inlet valve is not opened or the water mixing valve fails	Open the water inlet valve or replace the water mixing valve
The outlet water is cold(Heating indicator is off)	Power failure or power switch in off position	Check the power supply line
	Internal circuit failure	Contact the official technical support department
	Thermostat failure	Contact the official technical support department
The outlet water is cold(Heating indicator light is on)	Heating element failure	Contact the official technical support department
	Heating time is too short	Continue heating
	Water mixing valve failure	Replace the water mixing valve
	Internal circuit failure	Contact the official technical support department
Error code“E2”	The water heater is not filled with water and directly electrified, resulting in dry burning	Cut off the power supply, fill the water heater with water and then energize it
Error code“E3/E5”	Whether the sensor is damaged (E3 is sensor 1, E5 is sensor 2.)	Contact the official technical support department
Error code“E4”	The heating water temperature is out of control and exceeds 90°C	Contact the official technical support department

Note: If your electric water heater is operating abnormally, please handle it according to the "Fault Description and Handling Method". If you have any electrical problems, please contact the official technical support department designated by the company.

App connection instructions

- ① Download the "TuYa" APP from the App Store on your mobile phone.
- ② Make sure the mobile phone is connected to the wifi at home. When the electric water heater is on, press and hold the " ⏻ " Power button for 3 second.
- ③ Register and log in.

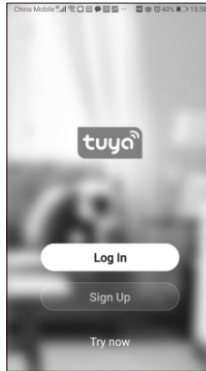

Unregistered users click “Sign up” , and then enter the interface to fill in the corresponding user information :If it is a registered user, just click " Log in".

④ Add Device

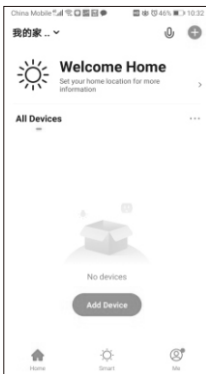

Step 1:Click "Add Devive"

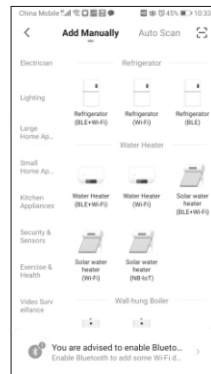

Step 2:Select "Water Heater(Wi-Fi)"
in "Large Home Appliances"

Add Device

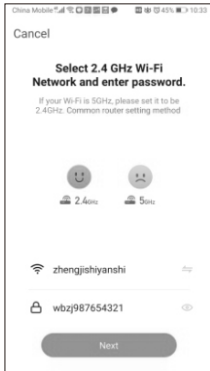

Step3: Select the Wi-Fi network that the device needs to access. And fill in the corresponding network password, and then click "Next".

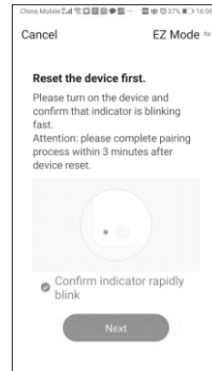

Step 4 : Confirm that the "Wi-Fi" indicator on the device panel is in the state of blinking. Check " Confirm indicator rapidly blink" and then click "Next".

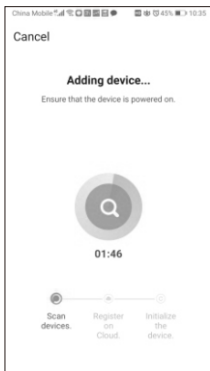

Step5: Wait for the network connection of the device.

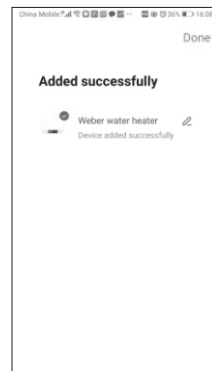







Step6: Edit the device name, and then click "Done".

Note: The electric water heater can only be bound to one APP account at a time. If it is bound to another APP account, the original APP account will be automatically unbound.

Packing List

After opening the packing box, please check the accessories and data attached to the machine according to the following table. If there is any damage or shortage, please contact the dealer or the after-sales service department of the company directly in time to serve you.

Please keep the operation manual properly for your future use and maintenance. The packing list is as follows

Name	Quantity	Dimension Sketch	Notes
Electric Water Heater	1 Unit		
Safety Valve	1 Piece		Mount to water inlet connection of water heater
Accessory Kit	1 Piece		Depending on the model purchased, the accessories may include one of the following options
			
Operation Manual	1 Piece		Keep properly
Energy Efficiency Label	1 Piece		

Recycling and Reuse



Dispose of packaging in an environmentally-friendly manner. This appliance is labelled in accordance with European Directive 2012/19/EU concerning used electrical and electronic appliances (waste electrical and electronic equipment-WEEE). The guideline determines the frame work for the return and recycling of use d appliances as applicable throughout to the EU.

PACKAGE INFORMATION: Packaging materials of the product are manufactured from recyclable materials in accordance with our National Environment Regulations. Do not dispose of the packaging materials together with the domestic or other wastes. Take them to the packaging material collection points designated by the local authorities.

Operation Manual